

## 1. ACCLIMATE

- Remove flooring from boxes and store inside the project area. Keep stacks 3' high or less, ensuring flooring is stored flat.
- Allow material to acclimate to room conditions for a minimum of 48 hours.
- Room temperature should be kept between 65°F - 85°F.

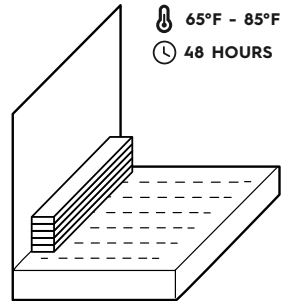

## 2. PREP

- Prepare subfloor to be dry, smooth, level, clean and dust-free

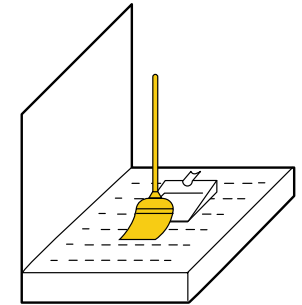

## 3. INSTALL

- Choose appropriate installation type depending on the size of the project and level of foot traffic.
- Recommended Adhesive:  
Urban 3020

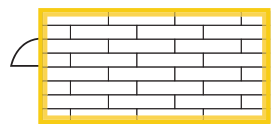

PERIMETER-ONLY  
ADHESIVE

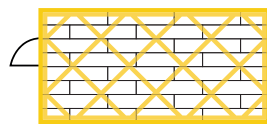

DIAMOND SHAPED  
ADHESIVE

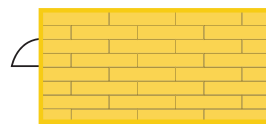

FULL SPREAD  
ADHESIVE

## 4. APPLY ADHESIVE

- Apply adhesive per the manufacturer's instructions across the entire installation area in sections that are workable within the allowed open time.
- Spread a 4" band of adhesive or tape around the entire perimeter.

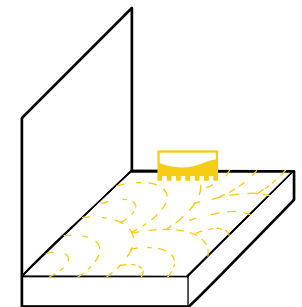

## 5. INSTALL PLANKS

- Work row by row ensuring to work out of multiple boxes.
- Inspect the rows to ensure they are tight without gaps or buckling.

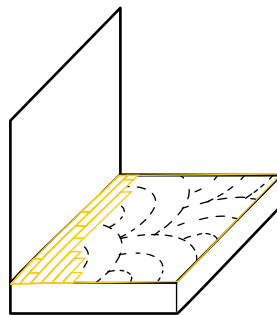

## 6. CURE

- Avoid direct sunlight while the adhesive or tape cures or a minimum of 72hrs post-installation, whichever is longer.

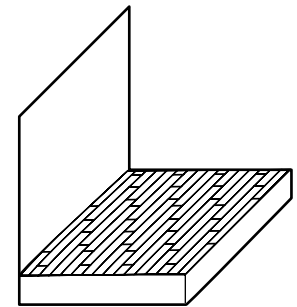

## RECOMMENDED ADHESIVE

Tuff-Grip Transitional Pressure Sensitive® (TPS) LVT/LVP Adhesive This solvent-free, non-flammable, easy troweling product provides excellent installation for luxury vinyl tile and plank over both porous and non-porous substrates. Urban 3020 provides high strength and moisture resistance.

